

Sistema deslizante sanfonado para portas de madeira, metal ou alumínio de até 20 kg Para fachadas ou varandas

- Estacionamentos de 90° frente das janelas, na parede lateral ou sem lateral para proteção ou privacidade
- Disponível com fecho interno HAWA
- Com dobradiças HAWA em aço inox
- Com uma ampla lista de referências no mundo inteiro

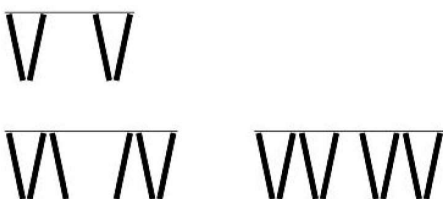

Variações de abertura



Exemplo de montagens

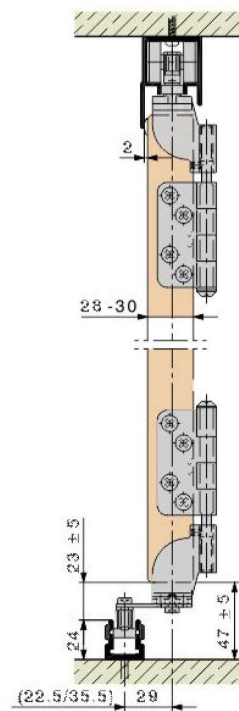
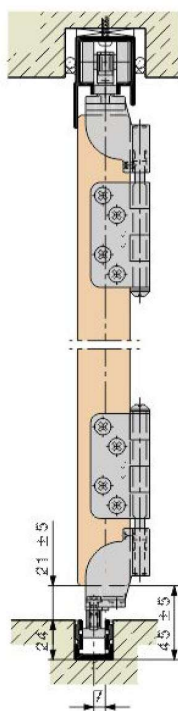
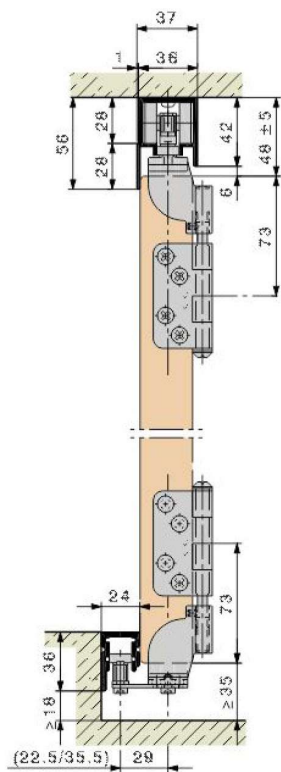



Dados técnicos	madeira	Alumínio
Peso máx.	20 kg	20 kg
Espessura	25-36 mm	28-32 mm
Largura máx.	600 mm	600 mm
Altura máx.	3000 mm	3000 mm

Para mais detalhes acesse catálogo no nosso site www.siforma.com.br ou consulte o atendimento especializado

Exemplo de montagens
Interno

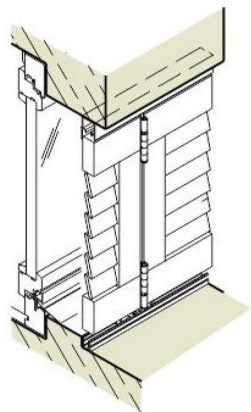

Exemplo de montagens
Externo

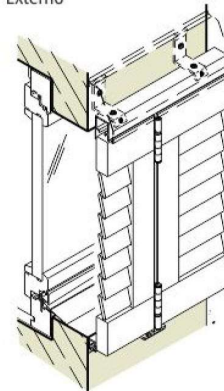

Conjunto de portas sanfonadas com calculo de folgas

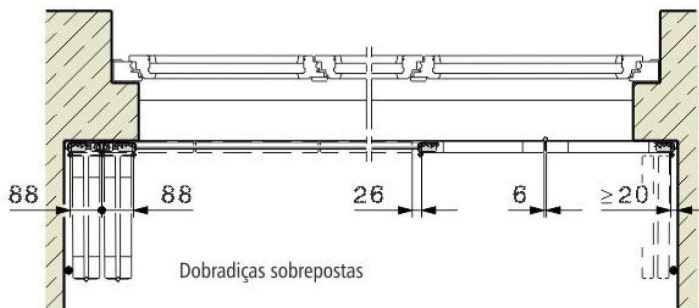

Dobradiças

para portas acima de 32 mm
as dobradiças devem ser embutidas

